

INSTALLATION AND OPERATION INSTRUCTION

FlowCon SM 50-150mm, 2”-6”

Install the **FlowCon SM** valve either in the supply or return pipe work for the unit. It is recommended that a strainer be installed prior to the valve body to prevent damage or blockage due to debris. **INSTALL THE VALVE HOUSING WITH THE FLOW DIRECTIONAL ARROW POINTING IN THE CORRECT DIRECTION.**

The valve body is available for double flange connections, i.e figure 1.

O-rings are supplied with the valve body and are used to seal the connections. Pls. make sure these are in place in the o-ring grooves in the inlet and outlet of the valve body, when installing the housing.

It is recommended to grease the o-rings with a silicone grease before installation.

IMPORTANT: Never use mineral oil or petrol based grease or oil on the o-rings.

Valve bodies are as standard supplied with **pressure/temperature fittings** (p/t plugs). Before finger mounting the p/t plugs in the body tappings, please seal the threads of the p/t plugs (**DO NOT OVER TIGHTEN**).

Fitting and orientation of the actuator.

Pls. install the valve so that the actuator is located upwards and not lower than the horizontal line to prevent condensation into the electronics (pls. see figure 2 next page).

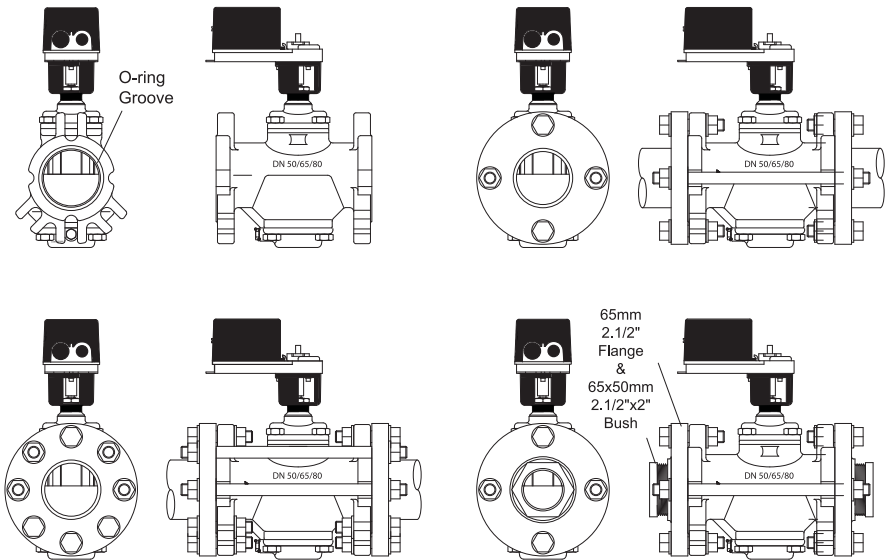

Figure 1

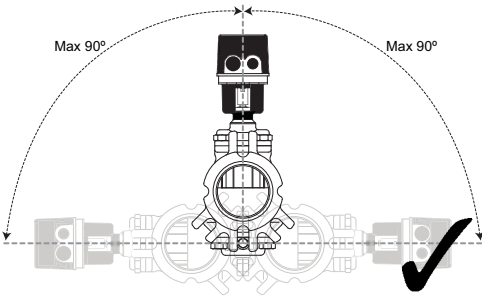
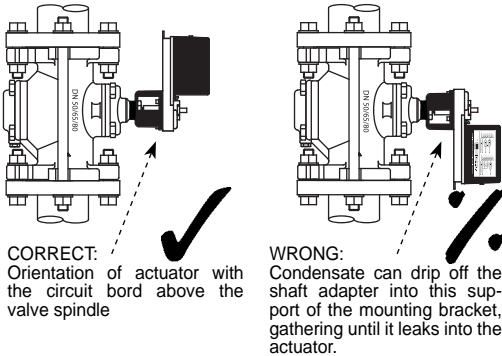

Figure 2

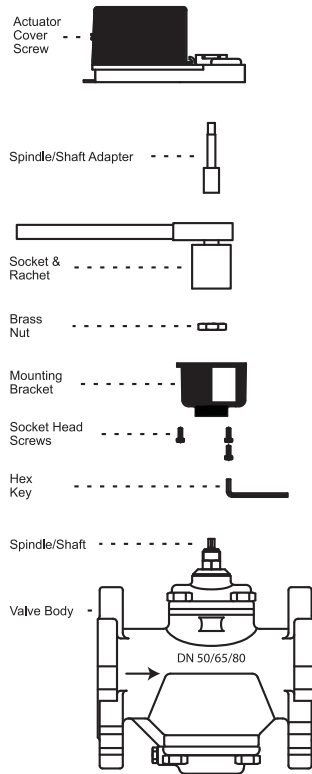

Figure 3

Valve and actuator mounting components and tool are shown in figure 3.

Actuator wiring and programming.

Remove the actuator cover by loosening the cover screw. Figure 4 illustrates the actuator circuit board layout and all relevant components when programming your actuator. Set the maximum flow DIP switches (refer to tables on page 6-8). If adjusting the DIP switch settings after power has been connected, press the reset button to input the new setting.

Figures 5-9 illustrate the different signal requirements, i.e. **Analog 2-10V**, **Analog 4-20 mA**, **Pulse Width Modulation** and **Digital Tri-**

state and how to apply resistors and wires. Connect the wiring according to the selected input signal.

500ohm resistors (the blue ones) are supplied for 4-20mA to 2-10V conversion and connected as illustrated in figure 5 (2-10V) or figure 6 (4-20mA).

Two 2.2Kohm resistors (the brown ones) are supplied for special consideration for digital/tri-state control. In this mode the actuator is sensitive to induced electrical voltages from other sources. To prevent such interference, wire one 2.2Kohm resistor between pins 1 and 4 and the second 2.2Kohm resistor between pins 1 and 3 (see figures 8 and 9).

Figure 4

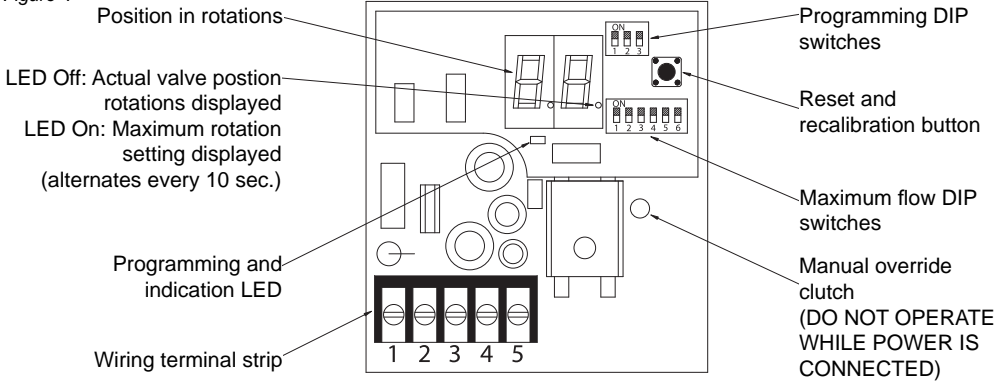

Figure 5

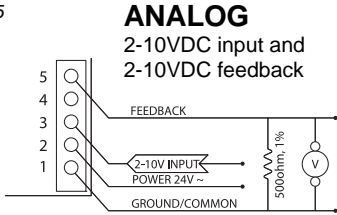

Figure 6

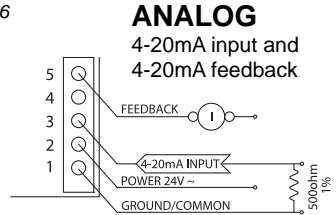

Figure 7

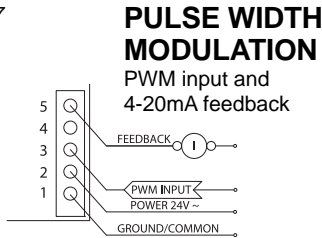

Figure 8

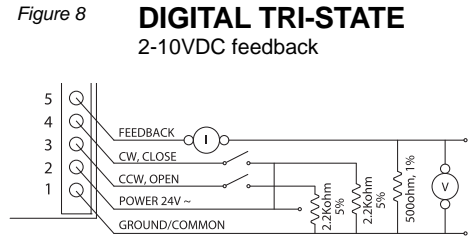
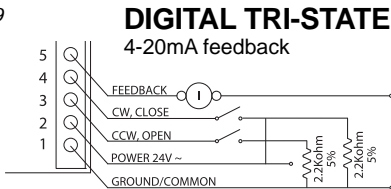

Figure 9



The actuator is factory preset for an analog signal. If the signal requirement must be changed, proceed with the instruction below:

Remove power and set all programming DIP switches to OFF.

Apply power and within 10 seconds, press and release the reset button.

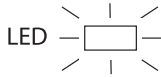
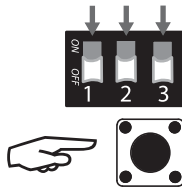

The programming and indication LED should start blinking.

Turn programming DIP switch #1, #2 or #3 ON, then OFF to select signal requirement.

Switch #1:
Digital/3-Point-Floating/Tri-state.

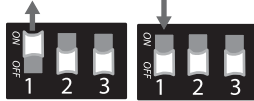

Switch #2:
PWM Pulse Width Modulation.

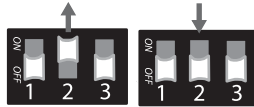

Switch #3:
Analog
2-10V or 4-20mA.

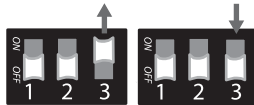

Normally Open or Normally Closed function setting.

The actuator is delivered from factory set to Normally Closed and an analog control signal so that a minimum signal of 2V or 4mA will close the valve and maximum signal of 10V or 20mA will open the valve to selected maximum flow. If changing to Normally Open, see below:

For Normally Open set programming switch #1 to ON.

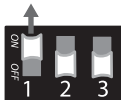

For Normally Closed set programming switch #1 to OFF.

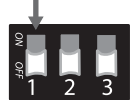

Failsafe Open or Failsafe Closed function setting.

This function applies to battery back up fail-safe models only. It provides power storage to drive the actuator either open to the maximum flow setting or fully closed in the event of a power supply failure. As standard the actuator is set to Failsafe Closed.

For Failsafe Open set programming switch #2 to ON.

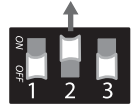

For Failsafe Closed set programming switch #2 to OFF.

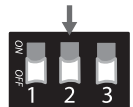

PWM time base resolution setting.

This function applies only if the actuator has been programmed to accept a pulse width modulation (PWM) signal. If with PWM, standard setting is 0.1 to 25 second/100mS resolution.

For 0.1 to 5 second/20mS resolution set programming switch #3 to ON.

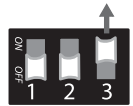

For 0.1 to 25 second/100mS resolution set programming switch #3 to OFF.

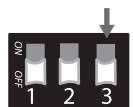

Actuator Zero and Span adjustment.

Remove power from the actuator. Re-apply power to terminal 2 and within 10 seconds, press and hold the reset button until the indication LED blinks once.



Release the reset button. The indication LED should remain illuminated.

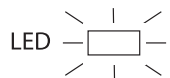

Apply the new zero voltage to terminal 3 (any value between 0 and 7VDC). Press and release the reset button to memorize this value. The LED should blink once as confirmation.

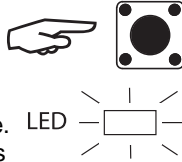

Apply the new maximum voltage to terminal 3 (any value between 3 and 10VDC and at least 3VDC greater than the zero value). Press and release the reset button to memorize this value. The indication LED should blink once as confirmation and then cease to be illuminated.

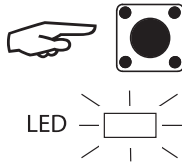

The actuator will now operate with the new zero value and span.

FAILURE: If the LED provides 3 sequences of 4 blinks, the zero and span programming was unsuccessful. This may occur if the difference between the zero and maximum voltages was not equal or greater than 3VDC.

NOTE: The feedback signal will always be 4-20mA or 2-10V and independent of the zero and span adjustment.

Circuit board diode over-torque warning signal.

Continual blinking indicates that the actuator torque output limit has been exceeded. This may have been caused by debris in the valve internals. Disconnect power and manually operate the valve to clear the debris. Re-apply power. The actuator will automatically recalibrate and reset. If the problem re-occurs, remove the valve body and check for debris.

Manual over-ride operation.

Remove actuator cover and DISCONNECT POWER. Failure to disconnect power may cause damage to the actuator gears. Fit the manual over-ride key (FlowCon No. ACC0001) onto the valve spindle. Press the clutch. Rotate the manual over-ride key to open or close the valve as required.

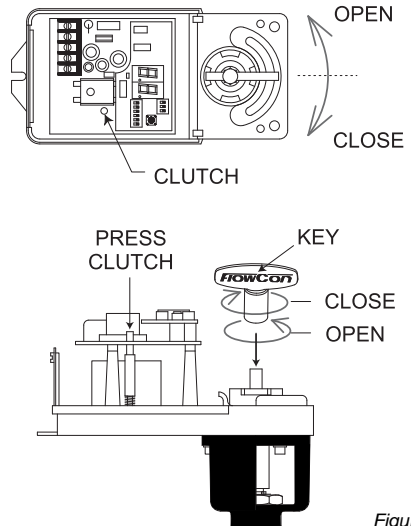

Figure 10

General.

Water must always be suitable treated, clean and free of debris. It is recommended that a strainer be installed prior to the valve body to prevent damage or blockage due to debris. Ensure that the valve is not in the fully closed position when filling the system with water. Further, it is recommended not to exceed maximum differential pressure control range.

Warranty obligation.

Failure to abide by all recommendations as per this installation and operation instruction will void warranty.

For latest updates please see www.flowcon.com

Maximum flow rate limitation DIP switch settings, SM3:

Maximum Flow Rate									Maximum Flow Rate DIP Switch Settings						Stem Rotations From Closed
Valve size: DN50-DN80 · 2"-3"															
35-400 kPaD 5.1-58 psid			35-400 kPaD 5.1-58 psid			80-400 kPaD 11.6-58 psid									
SM.3.0			SM.3.1			SM.3.2									
I/sec	I/hr	GPM	I/sec	I/hr	GPM	I/sec	I/hr	GPM	1	2	3	4	5	6	Rotations
1.48	5310	23.4	2.57	9240	40.7	3.55	12800	56.3	ON	ON	ON	ON	ON	ON	1.0
1.58	5700	25.1	2.81	10100	44.6	3.85	13900	61.0	OFF	ON	ON	ON	ON	ON	1.1
1.69	6080	26.8	3.05	11000	48.4	4.13	14900	65.6	ON	OFF	ON	ON	ON	ON	1.2
1.79	6460	28.5	3.27	11800	51.9	4.41	15900	69.9	OFF	OFF	ON	ON	ON	ON	1.3
1.90	6830	30.1	3.48	12500	55.3	4.67	16800	74.0	ON	ON	OFF	ON	ON	ON	1.4
2.00	7190	31.7	3.69	13300	58.5	4.92	17700	78.0	OFF	ON	OFF	ON	ON	ON	1.5
2.09	7540	33.2	3.88	14000	61.5	5.16	18600	81.8	ON	OFF	OFF	ON	ON	ON	1.6
2.19	7880	34.7	4.06	14600	64.3	5.38	19400	85.4	OFF	OFF	OFF	ON	ON	ON	1.7
2.28	8210	36.2	4.23	15200	67.0	5.60	20200	88.8	ON	ON	ON	OFF	ON	ON	1.8
2.37	8540	37.6	4.39	15800	69.6	5.81	20900	92.1	OFF	ON	ON	OFF	ON	ON	1.9
2.46	8860	39.0	4.54	16300	72.0	6.01	21600	95.3	ON	OFF	ON	OFF	ON	ON	2.0
2.55	9170	40.4	4.68	16900	74.3	6.19	22300	98.0	OFF	OFF	ON	OFF	ON	ON	2.1
2.63	9470	41.7	4.82	17300	76.4	6.37	22900	101	ON	ON	OFF	OFF	ON	ON	2.2
2.71	9770	43.0	4.94	17800	78.4	6.54	23600	104	OFF	ON	OFF	OFF	ON	ON	2.3
2.79	10100	44.3	5.06	18200	80.3	6.70	24100	106	ON	OFF	OFF	OFF	ON	ON	2.4
2.87	10300	45.5	5.17	18600	82.1	6.86	24700	109	OFF	OFF	OFF	OFF	ON	ON	2.5
2.94	10600	46.7	5.28	19000	83.7	7.00	25200	111	ON	ON	ON	ON	OFF	ON	2.6
3.02	10900	47.9	5.37	19300	85.2	7.14	25700	113	OFF	ON	ON	ON	OFF	ON	2.7
3.09	11100	49.0	5.47	19700	86.7	7.27	26200	115	ON	OFF	ON	ON	OFF	ON	2.8
3.16	11400	50.1	5.55	20000	88.0	7.40	26600	117	OFF	OFF	ON	ON	OFF	ON	2.9
3.22	11600	51.1	5.63	20300	89.3	7.52	27100	119	ON	ON	OFF	ON	OFF	ON	3.0
3.29	11800	52.1	5.70	20500	90.5	7.63	27500	121	OFF	ON	OFF	ON	OFF	ON	3.1
3.35	12100	53.1	5.77	20800	91.6	7.74	27900	123	ON	OFF	OFF	ON	OFF	ON	3.2
3.41	12300	54.0	5.84	21000	92.6	7.84	28200	124	OFF	OFF	OFF	ON	OFF	ON	3.3
3.46	12500	54.9	5.90	21200	93.5	7.94	28600	126	ON	ON	ON	OFF	OFF	ON	3.4
3.52	12700	55.8	5.95	21400	94.4	8.03	28900	127	OFF	ON	ON	OFF	OFF	ON	3.5
3.57	12900	56.6	6.01	21600	95.3	8.12	29200	129	ON	OFF	ON	OFF	OFF	ON	3.6
3.62	13000	57.4	6.06	21800	96.1	8.20	29500	130	OFF	OFF	ON	OFF	OFF	ON	3.7
3.67	13200	58.2	6.10	22000	96.8	8.28	29800	131	ON	ON	ON	OFF	OFF	ON	3.8
3.72	13400	58.9	6.15	22100	97.5	8.36	30100	133	OFF	ON	OFF	OFF	OFF	ON	3.9
3.76	13500	59.6	6.19	22300	98.2	8.44	30400	134	ON	OFF	OFF	OFF	OFF	ON	4.0
3.80	13700	60.3	6.23	22400	98.9	8.51	30600	135	OFF	OFF	OFF	OFF	OFF	ON	4.1
3.84	13800	60.9	6.27	22600	100	8.58	30900	136	ON	ON	ON	ON	ON	OFF	4.2
3.88	14000	61.5	6.31	22700	100	8.65	31100	137	OFF	ON	ON	ON	ON	OFF	4.3
3.91	14100	62.0	6.35	22900	101	8.72	31400	138	ON	OFF	ON	ON	ON	OFF	4.4
3.94	14200	62.5	6.39	23000	101	8.78	31600	139	OFF	OFF	ON	ON	ON	OFF	4.5
3.97	14300	63.0	6.42	23100	102	8.85	31900	140	ON	ON	OFF	ON	ON	OFF	4.6
4.00	14400	63.4	6.46	23300	102	8.91	32100	141	OFF	ON	OFF	ON	ON	OFF	4.7
4.03	14500	63.9	6.50	23400	103	8.98	32300	142	ON	OFF	OFF	ON	ON	OFF	4.8
4.05	14600	64.2	6.54	23500	104	9.04	32600	143	OFF	OFF	OFF	ON	ON	OFF	4.9
4.07	14700	64.6	6.58	23700	104	9.11	32800	144	ON	ON	ON	OFF	ON	OFF	5.0
4.09	14700	64.9	6.62	23800	105	9.18	33000	146	OFF	ON	ON	OFF	ON	OFF	5.1
4.11	14800	65.1	6.67	24000	106	9.25	33300	147	ON	OFF	ON	OFF	ON	OFF	5.2
4.12	14800	65.3	6.72	24200	107	9.32	33500	148	OFF	OFF	ON	OFF	ON	OFF	5.3
4.13	14900	65.5	6.77	24400	107	9.39	33800	149	ON	ON	OFF	OFF	ON	OFF	5.4
4.14	14900	65.7	6.82	24600	108	9.46	34100	150	OFF	ON	OFF	OFF	ON	OFF	5.5
4.15	14900	65.8	6.88	24800	109	9.54	34300	151	ON	OFF	OFF	OFF	ON	OFF	5.6
4.15	15000	65.9	6.94	25000	110	9.62	34600	153	OFF	OFF	OFF	OFF	ON	OFF	5.7
4.16	15000	65.9	7.01	25200	111	9.70	34900	154	ON	ON	ON	ON	OFF	OFF	5.8
4.16	15000	66.0	7.08	25500	112	9.79	35300	155	OFF	ON	ON	ON	OFF	OFF	5.9
4.16	15000	66.0	7.15	25700	113	9.88	35600	157	ON	OFF	ON	ON	OFF	OFF	6.0

Accuracy: Greatest of either ±5% of controlled flow rate or ±2% of maximum flow rate.

Maximum flow rate limitation DIP switch settings, SM4:

Maximum Flow Rate									Maximum Flow Rate DIP Switch Settings						Stem Rotations From Closed	
Valve size: DN80 and DN100 - 3"-4"																
35-400 kPaD 5.1-58 psid			60-400 kPaD 8.7-58 psid			60-400 kPaD 8.7-58 psid										
SM.4.1			SM.4.2			SM.4.3			1	2	3	4	5	6	Rotations	
l/sec	l/hr	GPM	l/sec	l/hr	GPM	l/sec	l/hr	GPM								
3.49	12600	55.4	4.73	17000	75.0	3.68	13300	58.3	ON	ON	ON	ON	ON	ON	1.0	
3.88	14000	61.6	5.29	19000	83.9	4.42	15900	70.0	OFF	ON	ON	ON	ON	ON	1.1	
4.26	15300	67.5	5.82	21000	92.0	5.13	18500	81.3	ON	OFF	ON	ON	ON	ON	1.2	
4.61	16600	73.1	6.33	22800	100	5.82	21000	92.3	OFF	OFF	ON	ON	ON	ON	1.3	
4.94	17800	78.4	6.82	24500	108	6.50	23400	103	ON	ON	OFF	ON	ON	ON	1.4	
5.26	18900	83.4	7.28	26200	115	7.15	25700	113	OFF	ON	OFF	ON	ON	ON	1.5	
5.56	20000	88.2	7.72	27800	122	7.78	28000	123	ON	OFF	OFF	ON	ON	ON	1.6	
5.84	21000	92.7	8.14	29300	129	8.39	30200	133	OFF	OFF	OFF	ON	ON	ON	1.7	
6.11	22000	97.0	8.54	30700	135	8.99	32400	142	ON	ON	ON	OFF	ON	ON	1.8	
6.36	22900	101	8.91	32100	141	9.56	34400	152	OFF	ON	ON	OFF	ON	ON	1.9	
6.60	23800	105	9.27	33400	147	10.1	36400	160	ON	OFF	ON	OFF	ON	ON	2.0	
6.82	24600	108	9.61	34600	152	10.7	38400	169	OFF	OFF	ON	OFF	ON	ON	2.1	
7.03	25300	112	9.93	35700	157	11.2	40200	177	ON	ON	OFF	OFF	ON	ON	2.2	
7.23	26000	115	10.2	36800	162	11.7	42100	185	OFF	ON	OFF	OFF	ON	ON	2.3	
7.41	26700	117	10.5	37800	167	12.2	43800	193	ON	OFF	OFF	OFF	ON	ON	2.4	
7.58	27300	120	10.8	38800	171	12.6	45500	200	OFF	OFF	OFF	OFF	ON	ON	2.5	
7.73	27800	123	11.0	39700	175	13.1	47100	207	ON	ON	ON	ON	OFF	ON	2.6	
7.88	28400	125	11.3	40500	179	13.5	48700	214	OFF	ON	ON	ON	OFF	ON	2.7	
8.01	28800	127	11.5	41300	182	13.9	50200	221	ON	OFF	ON	ON	OFF	ON	2.8	
8.14	29300	129	11.7	42000	185	14.3	51600	227	OFF	OFF	ON	ON	OFF	ON	2.9	
8.25	29700	131	11.9	42700	188	14.7	53000	233	ON	ON	OFF	ON	OFF	ON	3.0	
8.35	30100	132	12.0	43400	191	15.1	54300	239	OFF	ON	OFF	ON	OFF	ON	3.1	
8.45	30400	134	12.2	43900	194	15.4	55600	245	ON	OFF	OFF	ON	OFF	ON	3.2	
8.53	30700	135	12.4	44500	196	15.8	56800	250	OFF	OFF	OFF	ON	OFF	ON	3.3	
8.61	31000	137	12.5	45000	198	16.1	58000	255	ON	ON	ON	OFF	OFF	ON	3.4	
8.68	31300	138	12.6	45500	200	16.4	59100	260	OFF	ON	ON	OFF	OFF	ON	3.5	
8.74	31500	139	12.7	45900	202	16.7	60200	265	ON	OFF	ON	OFF	OFF	ON	3.6	
8.80	31700	140	12.9	46300	204	17.0	61200	269	OFF	OFF	ON	OFF	OFF	ON	3.7	
8.85	31900	140	13.0	46700	206	17.3	62100	274	ON	ON	ON	OFF	OFF	ON	3.8	
8.90	32000	141	13.1	47000	207	17.5	63000	278	OFF	ON	OFF	OFF	OFF	ON	3.9	
8.93	32200	142	13.1	47300	208	17.8	63900	281	ON	OFF	OFF	OFF	OFF	ON	4.0	
8.97	32300	142	13.2	47600	210	18.0	64700	285	OFF	OFF	OFF	OFF	OFF	ON	4.1	
9.00	32400	143	13.3	47800	211	18.2	65500	288	ON	ON	ON	ON	ON	OFF	4.2	
9.03	32500	143	13.4	48100	212	18.4	66200	292	OFF	ON	ON	ON	ON	OFF	4.3	
9.05	32600	144	13.4	48300	213	18.6	66900	295	ON	OFF	ON	ON	ON	OFF	4.4	
9.07	32600	144	13.5	48500	214	18.8	67600	297	OFF	OFF	ON	ON	ON	OFF	4.5	
9.09	32700	144	13.5	48700	214	18.9	68200	300	ON	ON	ON	OFF	ON	ON	OFF	4.6
9.10	32800	144	13.6	48800	215	19.1	68700	303	OFF	ON	OFF	ON	ON	OFF	4.7	
9.12	32800	145	13.6	49000	216	19.2	69200	305	ON	OFF	OFF	ON	ON	OFF	4.8	
9.13	32900	145	13.7	49200	217	19.4	69700	307	OFF	OFF	OFF	ON	ON	OFF	4.9	
9.15	32900	145	13.7	49300	217	19.5	70200	309	ON	ON	ON	OFF	ON	OFF	5.0	
9.16	33000	145	13.7	49500	218	19.6	70600	311	OFF	ON	ON	OFF	ON	OFF	5.1	
9.18	33000	146	13.8	49600	219	19.7	70900	312	ON	OFF	ON	OFF	ON	OFF	5.2	
9.19	33100	146	13.8	49800	219	19.8	71300	314	OFF	OFF	ON	OFF	ON	OFF	5.3	
9.21	33200	146	13.9	49900	220	19.9	71600	315	ON	ON	OFF	OFF	ON	OFF	5.4	
9.23	33200	146	13.9	50100	221	20.0	71900	316	OFF	ON	OFF	OFF	ON	OFF	5.5	
9.25	33300	147	14.0	50200	221	20.0	72100	317	ON	OFF	OFF	OFF	ON	OFF	5.6	
9.28	33400	147	14.0	50400	222	20.1	72300	318	OFF	OFF	OFF	OFF	ON	OFF	5.7	
9.31	33500	148	14.1	50600	223	20.1	72500	319	ON	ON	ON	ON	OFF	OFF	5.8	
9.34	33600	148	14.1	50800	224	20.2	72600	320	OFF	ON	ON	ON	OFF	OFF	5.9	
9.38	33800	149	14.2	51000	225	20.2	72700	320	ON	OFF	ON	ON	OFF	OFF	6.0	

Accuracy: Greatest of either ±5% of controlled flow rate or ±2% of maximum flow rate.



Denmark

Dubai

Singapore

USA

www.flowcon.com

Maximum flow rate limitation DIP switch settings, SM5

Maximum Flow Rate						Maximum Flow Rate DIP Switch Settings						Stem Rotations From Closed
Valve size: DN125 and DN150 - 5"-6"												Rotations
35-400 kPaD 5.1-58 psid			60-400 kPaD 8.7-58 psid									
SM.5.1			SM.5.2			1	2	3	4	5	6	
l/sec	l/hr	GPM	l/sec	l/hr	GPM							
6.48	23300	103	7.10	25600	113	ON	ON	ON	ON	ON	ON	1.0
7.24	26100	115	8.06	29000	128	OFF	ON	ON	ON	ON	ON	1.1
7.98	28700	127	8.98	32300	142	ON	OFF	ON	ON	ON	ON	1.2
8.69	31300	138	9.87	35500	157	OFF	OFF	ON	ON	ON	ON	1.3
9.39	33800	149	10.7	38600	170	ON	ON	OFF	ON	ON	ON	1.4
10.1	36200	160	11.6	41600	183	OFF	ON	ON	OFF	ON	ON	1.5
10.7	38600	170	12.4	44500	196	ON	OFF	OFF	ON	ON	ON	1.6
11.4	40900	180	13.1	47300	208	OFF	OFF	OFF	ON	ON	ON	1.7
12.0	43100	190	13.9	50000	220	ON	ON	ON	OFF	ON	ON	1.8
12.6	45200	199	14.6	52600	232	OFF	ON	ON	OFF	ON	ON	1.9
13.1	47300	208	15.3	55100	243	ON	OFF	ON	OFF	ON	ON	2.0
13.7	49300	217	16.0	57500	253	OFF	OFF	ON	OFF	ON	ON	2.1
14.2	51200	226	16.6	59800	264	ON	ON	OFF	OFF	ON	ON	2.2
14.7	53100	234	17.2	62100	274	OFF	ON	OFF	OFF	ON	ON	2.3
15.3	54900	242	17.8	64200	283	ON	OFF	OFF	OFF	ON	ON	2.4
15.7	56600	250	18.4	66300	292	OFF	OFF	OFF	OFF	ON	ON	2.5
16.2	58300	257	19.0	68300	301	ON	ON	ON	ON	OFF	ON	2.6
16.6	59900	264	19.5	70200	309	OFF	ON	ON	ON	OFF	ON	2.7
17.1	61500	271	20.0	72100	317	ON	OFF	ON	ON	OFF	ON	2.8
17.5	63000	277	20.5	73800	325	OFF	OFF	ON	ON	OFF	ON	2.9
17.9	64400	284	21.0	75500	333	ON	ON	OFF	ON	OFF	ON	3.0
18.3	65800	290	21.4	77200	340	OFF	ON	OFF	ON	OFF	ON	3.1
18.6	67100	295	21.9	78700	347	ON	OFF	OFF	ON	OFF	ON	3.2
19.0	68300	301	22.3	80200	353	OFF	OFF	OFF	ON	OFF	ON	3.3
19.3	69500	306	22.7	81700	360	ON	ON	ON	OFF	OFF	ON	3.4
19.6	70700	311	23.1	83100	366	OFF	ON	ON	OFF	OFF	ON	3.5
19.9	71700	316	23.4	84400	372	ON	OFF	ON	OFF	OFF	ON	3.6
20.2	72800	321	23.8	85700	377	OFF	OFF	ON	OFF	OFF	ON	3.7
20.5	73800	325	24.1	86900	383	ON	ON	OFF	OFF	OFF	ON	3.8
20.7	74700	329	24.5	88100	388	OFF	ON	OFF	OFF	OFF	ON	3.9
21.0	75600	333	24.8	89200	393	ON	OFF	OFF	OFF	OFF	ON	4.0
21.2	76400	337	25.1	90300	398	OFF	OFF	OFF	OFF	OFF	ON	4.1
21.4	77200	340	25.4	91400	403	ON	ON	ON	ON	ON	OFF	4.2
21.6	77900	343	25.7	92400	407	OFF	ON	ON	ON	ON	OFF	4.3
21.8	78600	346	25.9	93400	411	ON	OFF	ON	ON	ON	OFF	4.4
22.0	79200	349	26.2	94300	415	OFF	OFF	ON	ON	ON	OFF	4.5
22.2	79800	352	26.5	95200	420	ON	ON	OFF	ON	ON	OFF	4.6
22.3	80300	354	26.7	96100	423	OFF	ON	OFF	ON	ON	OFF	4.7
22.5	80800	356	26.9	97000	427	ON	OFF	OFF	ON	ON	OFF	4.8
22.6	81300	358	27.2	97800	431	OFF	OFF	OFF	ON	ON	OFF	4.9
22.7	81700	360	27.4	98600	435	ON	ON	ON	OFF	ON	OFF	5.0
22.8	82100	362	27.6	99400	438	OFF	ON	ON	OFF	ON	OFF	5.1
22.9	82400	363	27.8	100000	442	ON	OFF	ON	OFF	ON	OFF	5.2
23.0	82700	364	28.1	101000	445	OFF	OFF	ON	OFF	ON	OFF	5.3
23.0	83000	366	28.3	102000	448	ON	ON	OFF	OFF	ON	OFF	5.4
23.1	83200	367	28.5	102000	452	OFF	ON	OFF	OFF	ON	OFF	5.5
23.2	83400	367	28.7	103000	455	ON	OFF	OFF	OFF	ON	OFF	5.6
23.2	83500	368	28.9	104000	458	OFF	OFF	OFF	OFF	ON	OFF	5.7
23.2	83600	368	29.1	105000	461	ON	ON	ON	ON	OFF	OFF	5.8
23.3	83700	369	29.3	105000	465	OFF	ON	ON	ON	OFF	OFF	5.9
23.3	83800	369	29.5	106000	468	ON	OFF	ON	ON	OFF	OFF	6.0

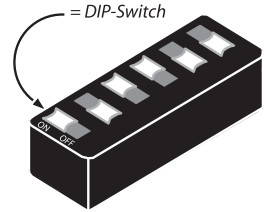

Example illustrated above:
ON-OFF-ON-ON-OFF-OFF
which gives:

- SM.3.1** (page 6) - 7.15 l/sec
- SM.4.2** (page 7) - 14.2 l/sec
- SM.5.2** - 29.5 l/sec.
(rotation 6.0)

Accuracy: Greatest of either ±5% of controlled flow rate or ±2% of maximum flow rate.